

| | | | | |
|------------|------------|---------|---------------------|-------------|
| 版本 REV. | 日期 DATE | ECN NO. | 变更内容 DESCRIPTION | 制图 DRAWN |
| | | | | |

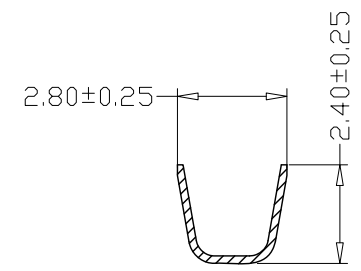

SEC:A-A

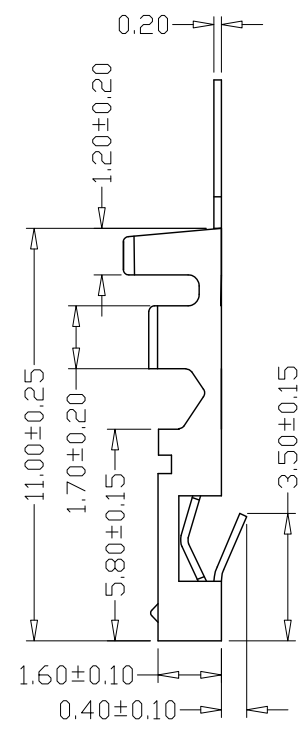
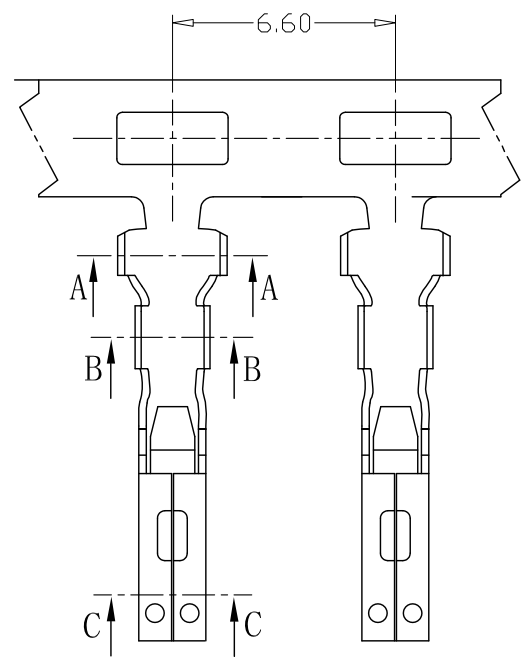
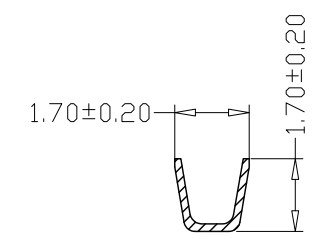

SEC:B-B

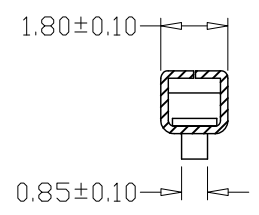

SEC:C-C

SPECIFICATIONS

- 1、Current Rating: 3A AC, DC
- 2、Voltage Rating: 250V AC, DC
- 3、Temperatuer Range: -25°C~+85°C
- 4、Contact Resistance: 20mΩ Max
- 5、Insulation Resistance: 1000MΩ Min
- 6、Withstanding Voltang: 1000V AC/minute
- 7、Material:Phosphoric bronze Tin-plated
- 8、Applicable Wire Sizes:AWG#22~28#

| | | | | | | | |
|------------------|------------|----------------|-------------------|---|-----------|-------------|-----|
| GENREL TOLERANCE | | 制图 Mapping | 张迎春 2022、09、19 | 料号 PART NO. | A25408-PT | 版本 REV. | A |
| X±0.25 | X°±2° | 审核 Audit | 钱岳生 2022、09、19 | 品名 TITLE | SYP母端 | 页次 SHEET | 1/1 |
| .X±0.25 | .X°±1° | 核准 Approved | 张名 2022、09、20 | 客户料号 CUTM. NO. | | | |
| .XX±0.15 | .XX°±0.5° | 单位 Units | mm | 比例 SCALE | | | |
| .XXX±0.10 | .XXX°±0.5° | | | 乐清市宏一电子有限公司 YueQing HongYiElectronics Co.,Ltd | | | |

| | | | | |
|------------|------------|---------|---------------------|-------------|
| 版本 REV. | 日期 DATE | ECN NO. | 变更内容 DESCRIPTION | 制图 DRAWN |
| | | | | |

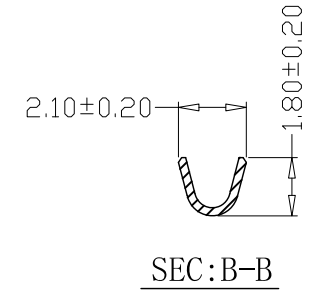
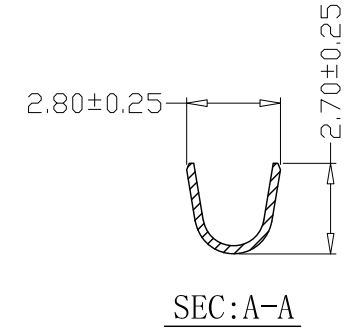
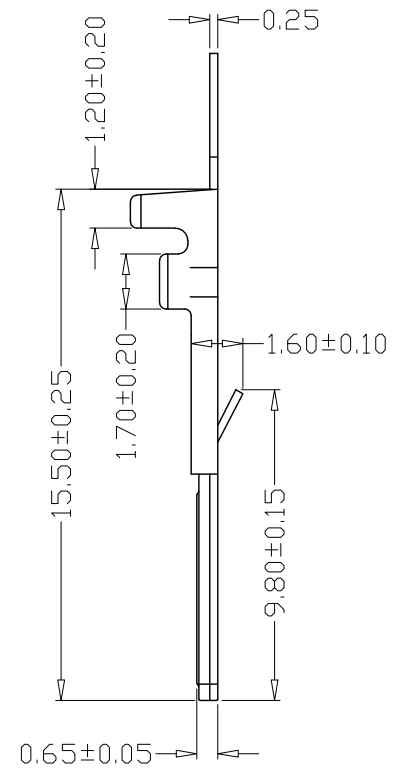
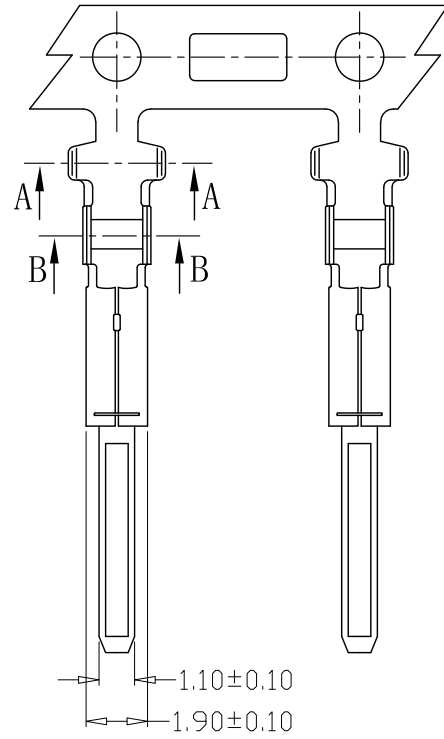

SPECIFICATIONS

- 1、Current Rating: 3A AC, DC
- 2、Voltage Rating: 250V AC, DC
- 3、Temperatuer Range: -25°C~+85°C
- 4、Contact Resistance: 20mΩ Max
- 5、Insulation Resistance: 1000MΩ Min
- 6、Withstanding Voltang: 1000V AC/minute
- 7、Material:Phosphoric bronze Tin-plated
- 8、Applicable Wire Sizes:AWG#22~28#

| | | | | | | | |
|------------------|------------|----------------|-------------------|-------------------|-----------|--|-----|
| GENEAL TOLERANCE | | 制图 Mapping | 张迎春 2022、09、19 | 料号 PART NO. | A25408-RT | 版本 REV. | A |
| X.±0.25 | X.°±2° | 审核 Audit | 钱岳生 2022、09、19 | 品名 TITLE | SYP公端 | 页次 SHEET | 1/1 |
| .X±0.25 | .X°±1° | 核准 Approved | 张名 2022、09、20 | 客户料号 CUTM. NO. | | 乐清市宏一电子有限公司 YueQing HongYi Electronics Co., Ltd | |
| .XX±0.15 | .XX°±0.5° | 单位 Units | mm | 比例 SCALE | | | |
| .XXX±0.10 | .XXX°±0.5° | | | | | | |

| | | | | |
|------------|------------|---------|---------------------|-------------|
| 版本 REV. | 日期 DATE | ECN NO. | 变更内容 DESCRIPTION | 制图 DRAWN |
| | | | | |

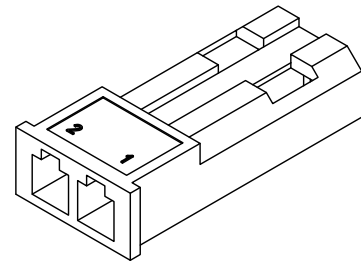
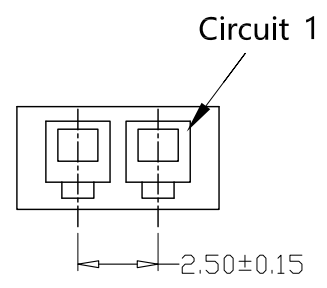

- SPECIFICATIONS
- 1、Current Rating: 3A AC, DC
 - 2、Voltage Rating: 250V AC, DC
 - 3、Temperatuer Range: -25℃~+85℃
 - 4、Contact Resistance: 20mΩ Max
 - 5、Insulation Resistance: 1000MΩ Min
 - 6、Withstanding Voltang: 1000V AC/minute
 - 7、Material: Wafer Nylon66, UL94V-0

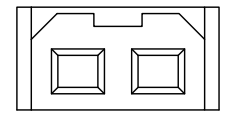
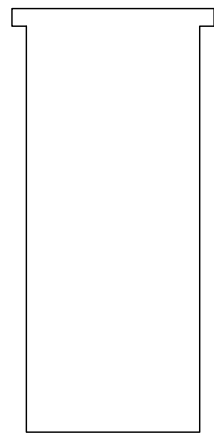
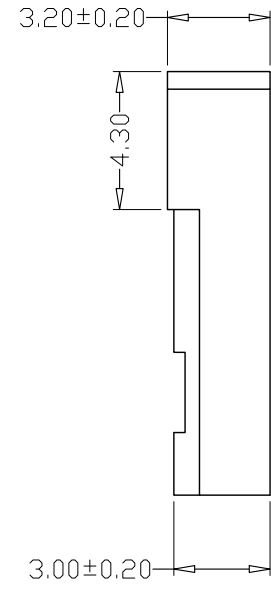
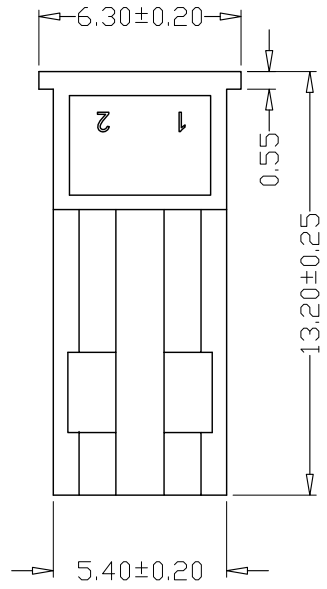

| | | | | | | | |
|-------------------|------------|----------------|-------------------|--|-----------|-------------|-----|
| GENEERL TOLERANCE | | 制图 Mapping | 张迎春 2022、09、19 | 料号 PART NO. | A25408-2P | 版本 REV. | A |
| X±0.25 | X°±2° | 审核 Audit | 钱岳生 2022、09、19 | 品名 TITLE | SYP公壳 | 页次 SHEET | 1/1 |
| .X±0.25 | .X°±1° | 核准 Approved | 张名 2022、09、20 | 客户料号 CUTM. NO. | | | |
| .XX±0.15 | .XX°±0.5° | 单位 Units | mm | 比例 SCALE | | | |
| .XXX±0.10 | .XXX°±0.5° | | | 乐清市宏一电子有限公司 YueQing HongYi Electronics Co., Ltd | | | |

| | | | | |
|------------|------------|---------|---------------------|-------------|
| 版本 REV. | 日期 DATE | ECN NO. | 变更内容 DESCRIPTION | 制图 DRAWN |
| | | | | |

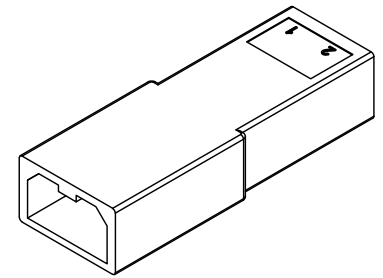
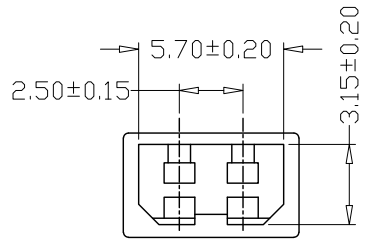

SPECIFICATIONS

- 1、Current Rating: 3A AC, DC
- 2、Voltage Rating: 250V AC, DC
- 3、Temperatuer Range: -25°C~+85°C
- 4、Contact Resistance: 20mΩ Max
- 5、Insulation Resistance: 1000MΩ Min
- 6、Withstanding Voltang: 1000V AC/minute
- 7、Material:Wafer Nylon66, UL94V-0

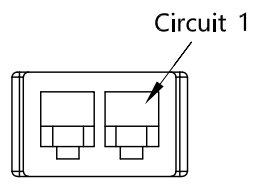
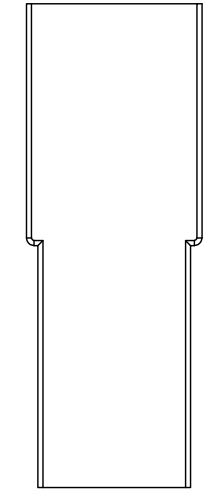
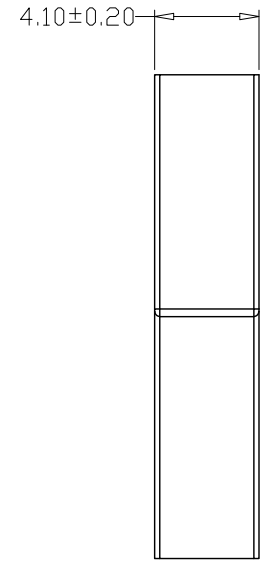
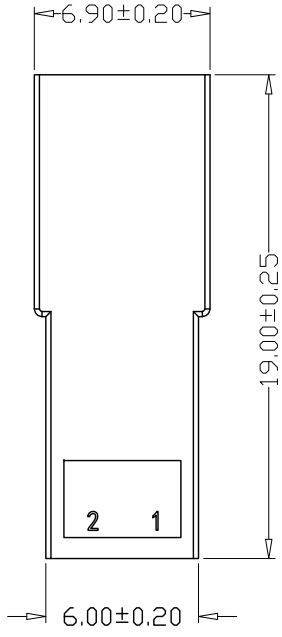

| | | | | | | | |
|-------------------|------------|---|-------------------|-------------------|-----------|-------------|-----|
| GENEERL TOLERANCE | | 制图 Mapping | 张迎春 2022、09、19 | 料号 PART NO. | A25408-2R | 版本 REV. | A |
| X±0.25 | X°±2° | 审核 Audit | 钱岳生 2022、09、19 | 品名 TITLE | SYP母壳 | 页次 SHEET | 1/1 |
| .X±0.25 | .X°±1° | 核准 Approved | 张名 2022、09、20 | 客户料号 CUTM. NO. | | | |
| .XX±0.15 | .XX°±0.5° | 单位 Units | mm | 比例 SCALE | | | |
| .XXX±0.10 | .XXX°±0.5° | 乐清市宏一电子有限公司 YueQing HongYi Electronics Co., Ltd | | | | | |